

# Screws

This worksheet is about screws used to fix wood together. It tells you about the different types of screws and how to fix them.

## What you will learn

When you have finished this worksheet, you should be able to:

- Choose the correct screw and screwdriver for a job.
- Drive screws safely and correctly.

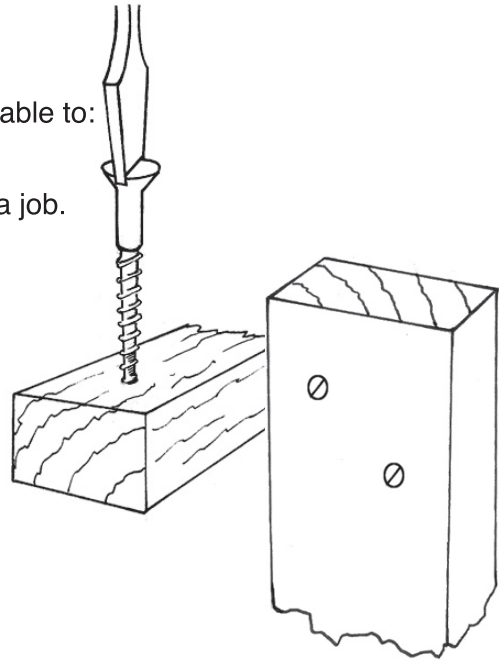

## Things you need before you start

### Materials

You will need some scrap timber and some screws to work with.

.....

### Tools or equipment

Measuring and marking tools

Drill

Screwdrivers

.....

# What are screws used for?

Screws are used to fix timber to:

Other timber

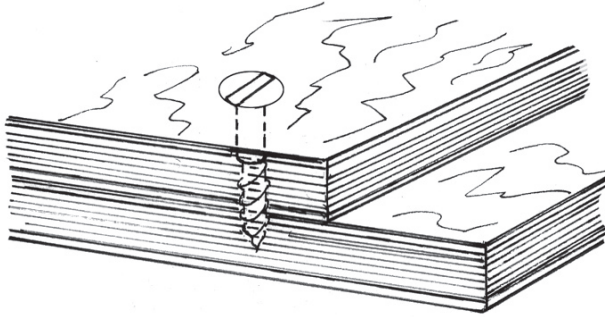

Hardware: door handles and hinges

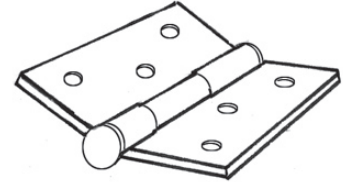
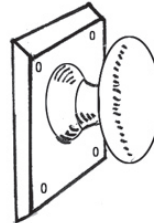

## Screws:

- Look neat
- Are stronger than a nail
- Take longer to fix than a nail
- Are used for finer jobs in carpentry

## How do they work?

A hole is drilled first, the screw is put in the hole and turned. T

he threads on the screw grip the wood fibres and pull the screw into the timber.

*Screws grip best across the grain*

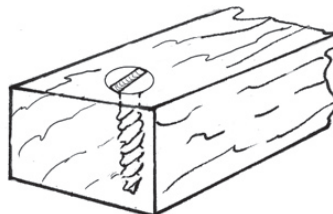

*They pull out more easily in end grain*

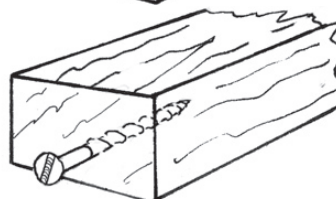

Screws are stronger than nails when forces try to pull the joint apart — the screw grips well.

# Types of Screws

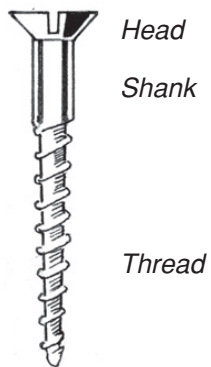

Screws are usually made of steel. They can be galvanized or plated. They can also be made of brass or stainless steel to make them rust-proof.

Screws come in all sorts of shapes and sizes. Some examples are;

**Round head**



**Countersunk head**



**Raised head**



## Types of drive

The main types of drive head for screws are:

**Slot or square tipped**



**Phillips**

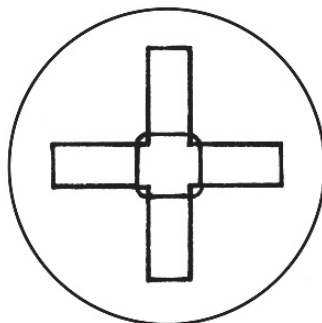

**Pozidrive**

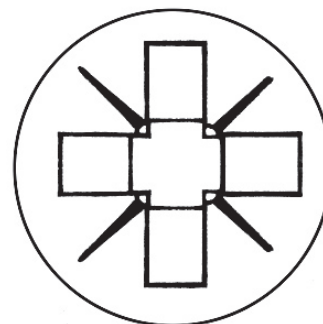

Each type needs the correct type of screwdriver to work properly. It is easy to confuse the Phillips cross-head and the Pozidrive screw heads. Look for the four extra small marks on the Pozidrive.

Each type of drive head also comes in different sizes to match the size of the screw. Screwdrivers also come in different sizes to fit.

If you use the wrong type or wrong size of screwdriver, you may have trouble driving the screw and you are likely to damage the head.

## Choosing the right size of screw

The best length for a screw is: about  $\frac{3}{4}$  the thickness of the two pieces of timber.

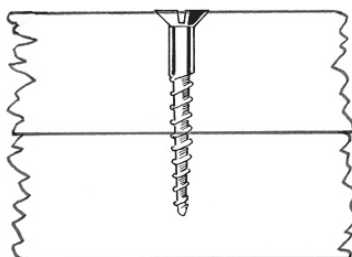

The length of screw for attaching hinges and handles should be 15mm–30mm.

# Putting in screws

This job is called 'driving' a screw

## Starting a screw

Drill a pilot hole in hard timber to help to start the screw. The hole should be about half the thickness of the screw shank.

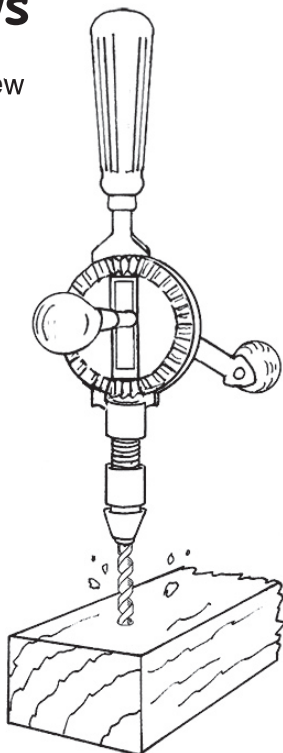

**When you are joining two pieces of timber, drill a hole through the top piece of timber. The hole should be the same thickness as the screw.**

**Countersink the hole, if needed.**

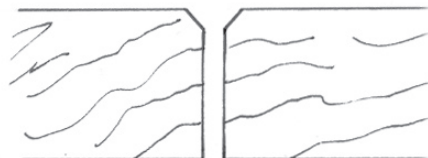

Use one hand to hold the screw upright and put the point in the drilled hole.

**Keep it square to timber.**

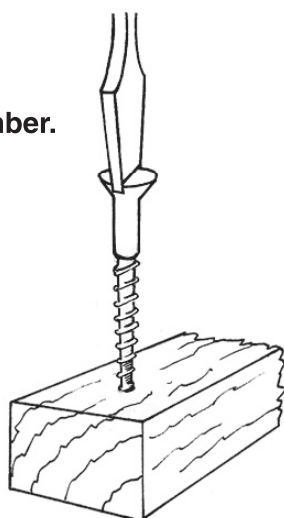

Use your other hand to put the driver in the head of the screw.

Gently turn the screw clockwise until it grips in the hole.

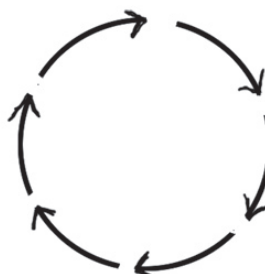

**Careful of your fingers!**

## Driving a screw

Once the screw has gripped firmly in the hole, take your fingers out of the way !

Twist the screw clockwise to make it go in

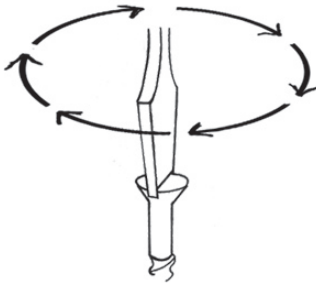

Twist the other way (counter clockwise) to screw out

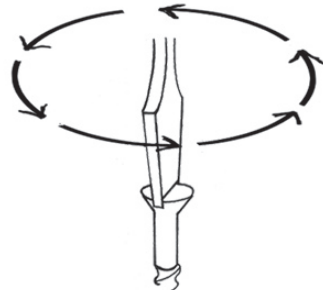

If the screw driver slips it will hurt you. Keep your fingers out of the way!

## Finishing

Screw in until the top of the head is level with the timber surface.

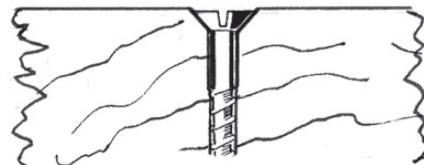
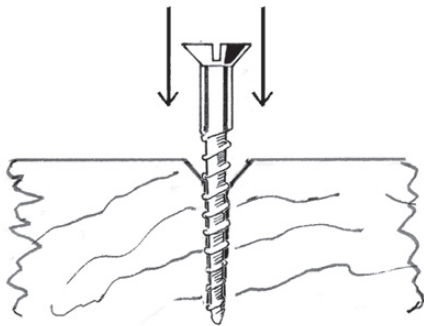

## Screws can split timber

Drill pilot holes

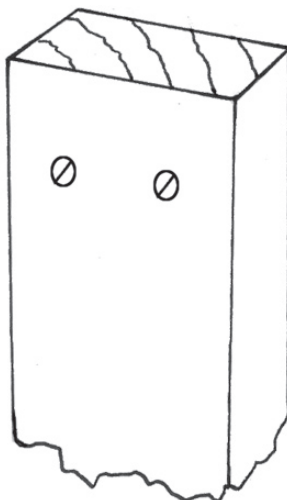

Stagger places

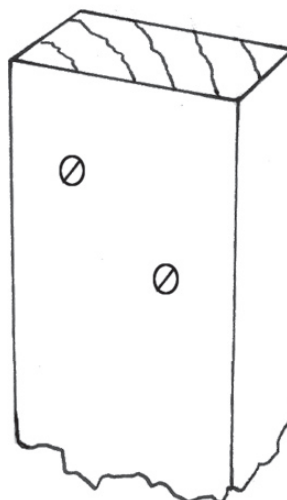

Keep away from ends of timber or the timber may split

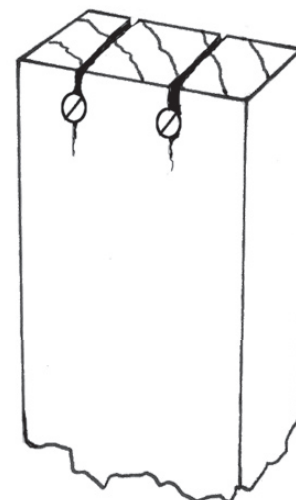

**Ask questions about anything you do not understand.**

## **Safety**

- Screw heads and threads can have sharp edges.
- If a screw driver slips it will hurt you. Keep your fingers out of the way!
- If you are putting screws into a wall — be careful that there are no pipes or electric cables inside!